

BOSE[®]



LIFESTYLE[®] 135

HOME ENTERTAINMENT SYSTEM

Setup Guide | Guía de instalación | Guide d'installation

SAFETY INFORMATION

Please read this guide

Please take the time to follow the instructions in this guide carefully. They will help you set up and operate your system properly and enjoy its advanced features. Please save this guide for future reference.

All Bose products must be used in accordance with local, state, federal, and industry regulations.

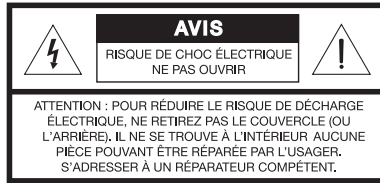
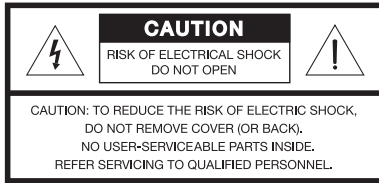

 The lightning flash with arrowhead symbol within an equilateral triangle alerts the user to the presence of uninsulated, dangerous voltage within the system enclosure that may be of sufficient magnitude to constitute a risk of electric shock.

 The exclamation point within an equilateral triangle alerts the user to the presence of important operating and maintenance instructions in this guide.

WARNINGS:

- To prevent electric shock, match the wide blade of the line cord plug to the wide slot of the AC (mains) receptacle. Insert fully.
- To reduce the risk of fire or electrical shock, do not expose the product to rain or moisture.
- Do not expose this apparatus to dripping or splashing, and do not place objects filled with liquids, such as vases, on or near the apparatus. As with any electronic products, use care not to spill liquids into any part of the system. Liquids can cause a failure and/or a fire hazard.
- Do not place any naked flame sources, such as lighted candles, on or near the apparatus.
- Contains small parts that may be a choking hazard. Not suitable for children under age 3.



CAUTIONS:

- Make no modifications to the system or accessories. Unauthorized alterations may compromise safety, regulatory compliance, and system performance, and may void the warranty.
- Long-term exposure to loud music may cause hearing damage. It is best to avoid extreme volume when using headphones, especially for extended periods.

Notes:

- Where the mains plug or appliance coupler is used as the disconnect device, such disconnect device shall remain readily operable.
- The product must be used indoors. It is neither designed nor tested for use outdoors, in recreation vehicles, or on boats.
- The product label is located on the bottom or the back of the product.
- The interconnect cables included with this system are not approved for in-wall installation. Please check your local building codes for the correct type of wire and cable required for in-wall installation.
- This product is intended to be used only with the power supply provided.



廢電池請回收

Please dispose of used batteries properly, following any local regulations. Do not incinerate.



This product conforms to all EU Directive requirements as applicable by law. The complete Declaration of Conformity can be found at www.Bose.com/static/compliance.

Additional safety information

See the additional instructions on the *Important Safety Information* sheet enclosed in the shipping carton.

Important Safety Instructions

1. Read these instructions.
2. Keep these instructions.
3. Heed all warnings.
4. Follow all instructions.
5. Do not use this apparatus near water.
6. Clean only with a dry cloth.
7. Do not block any ventilation openings. Install in accordance with the manufacturer's instructions.
8. Do not install near any heat sources such as radiators, heat registers, stoves, or other apparatus (including amplifiers) that produce heat.
9. When a polarized plug is used; Do not defeat the safety purpose of the polarized or grounding-type plug. A polarized plug has two blades with one wider than the other. A grounding type plug has two blades and a third grounding prong. The wide blade or the third prong are provided for your safety. If the provided plug does not fit into your outlet, consult an electrician for replacement of the obsolete outlet.
10. Protect the power cord from being walked on or pinched particularly at plugs, convenience receptacles, and the point where they exit from the apparatus.
11. Only use attachments/accessories specified by the manufacturer.
12. Use only with the cart, stand, tripod, bracket, or table specified by the manufacturer, or sold with the apparatus. When a cart is used, use caution when moving the cart/apparatus combination to avoid injury from tip-over.
13. Unplug this apparatus during lightning storms or when unused for long periods of time.
14. Refer all servicing to qualified personnel. Servicing is required when the apparatus has been damaged in a way, such as power-supply cord or plug is damaged, liquid has been spilled or objects have fallen into the apparatus, the apparatus has been exposed to rain or moisture, does not operate normally, or has been dropped.



HDMI and the HDMI logo are trademarks or registered trademarks of HDMI Licensing LLC in the United States and other countries.

iPod and iPhone are trademarks of Apple Inc., registered in the U.S. and other countries.

©2011 Bose Corporation. No part of this work may be reproduced, modified, distributed, or otherwise used without prior written permission.

CONTENTS **5**

WELCOME **6**

Thank you	6
Unpacking	6
Wall mounting kit	7

SYSTEM SETUP **8**

Putting the system together	8
Step 1: Set up the speaker array	8
Step 2: Set up the control console	11
Step 3: Set up the Acoustimass® module	14
First time startup	15
Step 1: Set up the remote control	16
Step 2: Turn your system on and follow the on-screen instructions	16
If you have setup problems	17
Contacting customer service	17

WELCOME

Thank you

Thank you for choosing a Bose® LIFESTYLE® 135 system for your home. This guide provides step-by-step instructions for setting up your new system.

Your new home entertainment system includes a speaker array, control console, Acoustimass module, universal remote control and a dock for iPod or iPhone.

Unpacking

As you carefully unpack the carton, if any part appears damaged, do not attempt to use it. Notify Bose or your authorized Bose dealer immediately. For Bose contact information, refer to the address sheet included in the carton.

Be sure to save all of the packing materials. These provide the safest means for any necessary shipping or transporting.

Carton contents:

- **Speaker array**

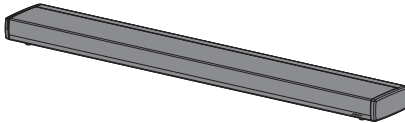

- **Acoustimass® module**

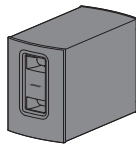

- **Accessory kits**

Each kit is identified by an icon on the box. The icons appear in the system setup steps to indicate where parts are located.

Cables and power cords kit



Audio input cable



AC power cord*



AM antenna

*The appropriate power cords for your region are supplied.

Remote control kit



Remote control



Batteries



ADAPTiQ® audio calibration headset



Dock for iPod or iPhone



FM antenna



IR emitter cable



Stereo audio cable

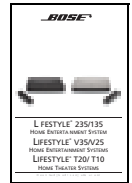

Operating Guide



USB flash drive (for system updating only)



Speaker array extension feet



Acoustimass module feet

Control console kit

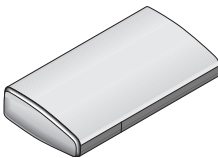

Control console

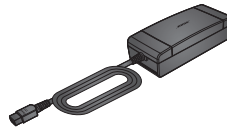

Power supply



HDMI™ cable

Wall mounting kit

The speaker array can be mounted on a wall. If you wish to do this, contact Bose to purchase the WB-135 Wall Mount Kit.

CAUTION: Do not use any wall-mounting hardware other than the WB-135 Wall Mount Kit to mount the speaker array on a wall.

CAUTION: Do not place the speaker array near or over a source of heat, such as a fireplace. Any damage that may occur to your speaker array as a result of placing it over a fireplace will not be covered by the limited warranty on your LIFESTYLE® system.

SYSTEM SETUP

Putting the system together

Note: The LIFESTYLE® 135 system uses the reflective surfaces of your room to deliver wide, spacious sound. For best sound quality, the speaker array should not be placed inside a cabinet, or diagonally in a corner.

Note: To avoid wireless interference, keep other wireless equipment, such as wireless computer network routers, cordless phones, microwave ovens, or other WIFI-enabled audio/video devices away from the speaker array and Acoustimass® module.

Step 1: Set up the speaker array

What you need:

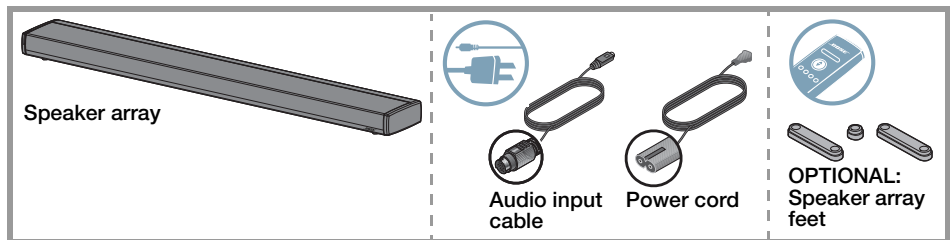

A. Lay the speaker array grille-side down on the table in front of your TV.

Note: To protect the surface of your table you may want to put a protective cloth under the speaker array until setup is complete. The foam bag removed from the speaker array could be used for this purpose.

Note: Be sure to remove all protective films from the speaker array before operating the system. They may affect acoustic performance if left in place.

B. Plug the audio input cable into the connector labeled **Audio In** on the speaker array. Make sure the flat surface with the arrow on the plug faces up.

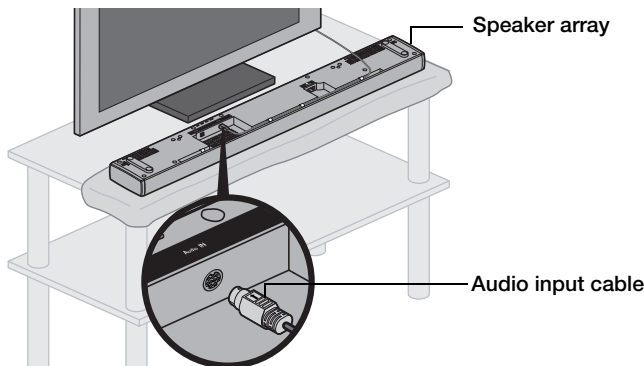

C. Plug the small end of the power cord into the connector labeled **Power**.

Note: Do not plug the power cord into an AC power outlet at this time. You will be instructed to do this later in the setup process.

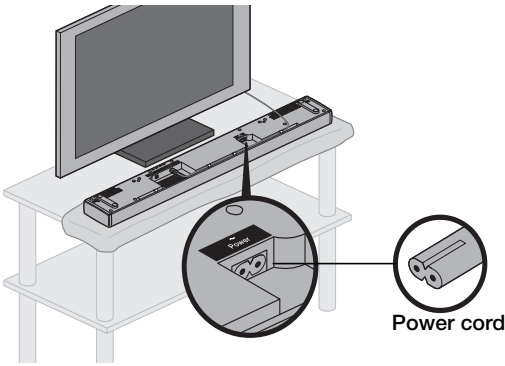

D. Arrange the cables as needed for your setup location.

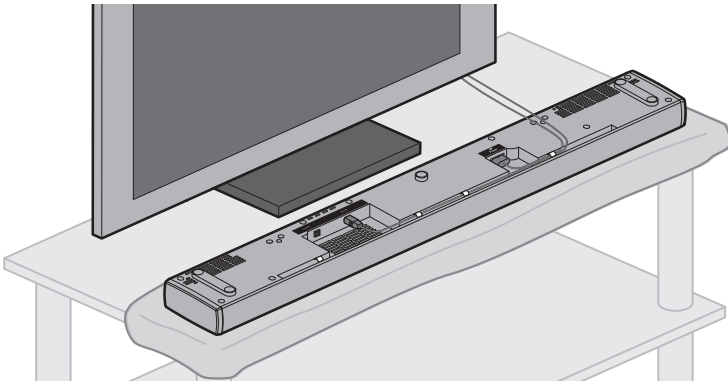

OPTIONAL: Secure cables under the clips in the channel running along the length of the speaker array.

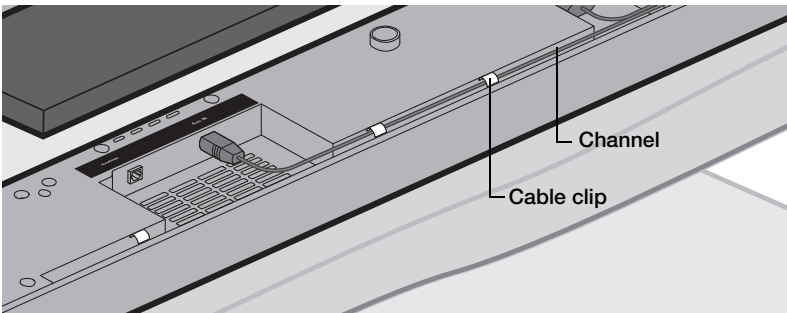

SYSTEM SETUP

- E. Turn the speaker array over and place it in front of your TV with the speaker grille facing into the room.

CAUTION: The speaker array must be placed on a solid flat surface. For proper support, all of the feet on the bottom of the speaker array must be resting on the table top

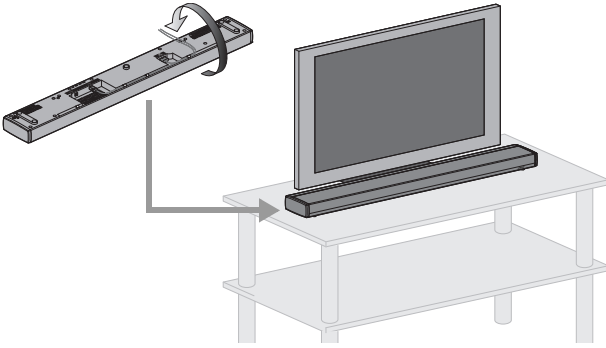

CAUTION: When positioning the speaker array, make sure it is not blocking any ventilation openings on your TV. Refer to the owner's guide that came with your TV and install in accordance with the manufacturer's instructions.

- F. OPTIONAL: To raise the speaker array and allow more space under it, you can install the optional extension feet (supplied).

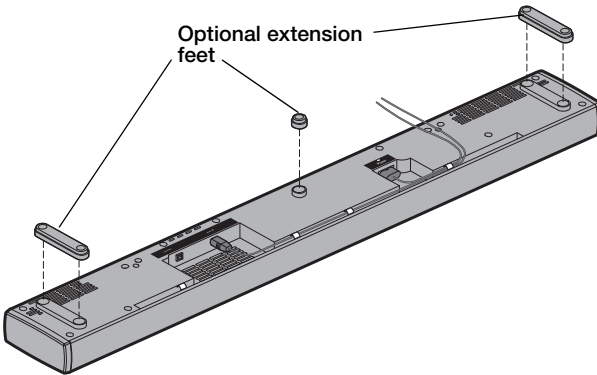

Step 2: Set up the control console

What you need:

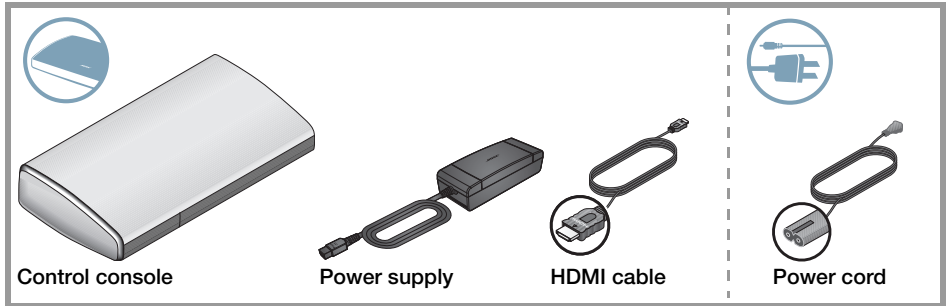

A. Place the control console on a flat, stable surface near your TV.

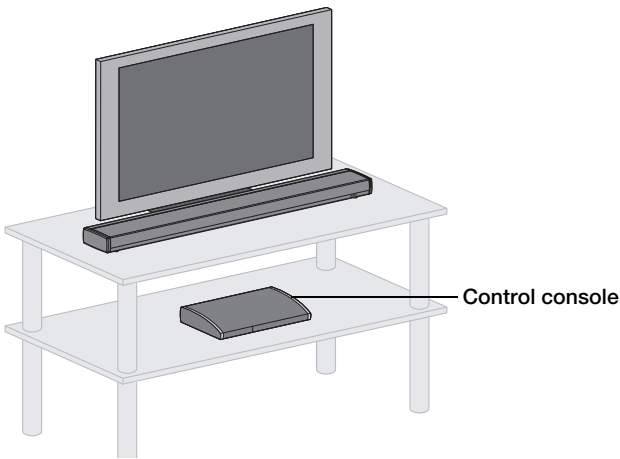

Note: Until your system is completely installed, it may be helpful to keep the control console positioned for easy access to its rear connection panel.

SYSTEM SETUP

- B.** Plug one end of the HDMI cable into an HDMI INPUT connector on your TV.

Note: If an HDMI cable is already connected to an HDMI input on your TV, you can use this cable. Just disconnect the other end.

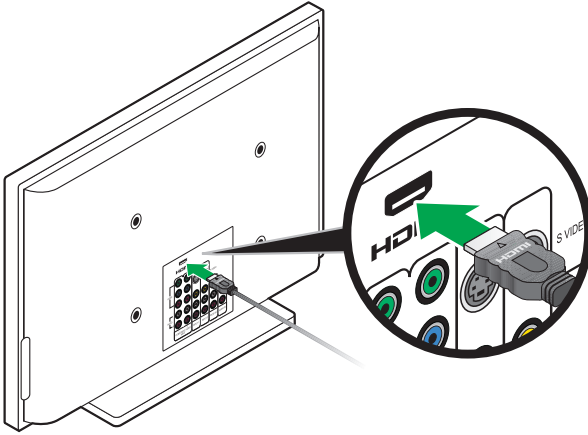

- C.** Plug the other end of the HDMI cable you are using into the connector labeled **HDMI OUT Video to TV** on the control console.

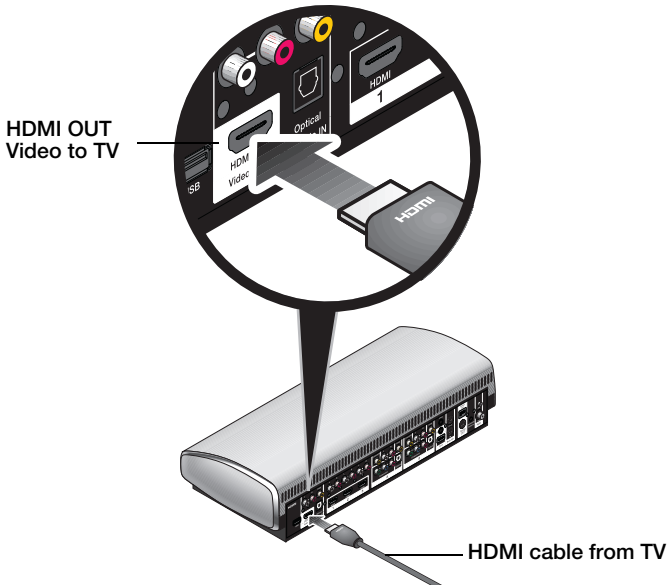

- D.** Plug the audio input cable coming from the speaker array into the connector labeled **Audio Out** on the control console.

Make sure the flat surface with the arrow on the plug faces up.

Note: Make sure the audio input cable is not plugged into a Bose® link connector.

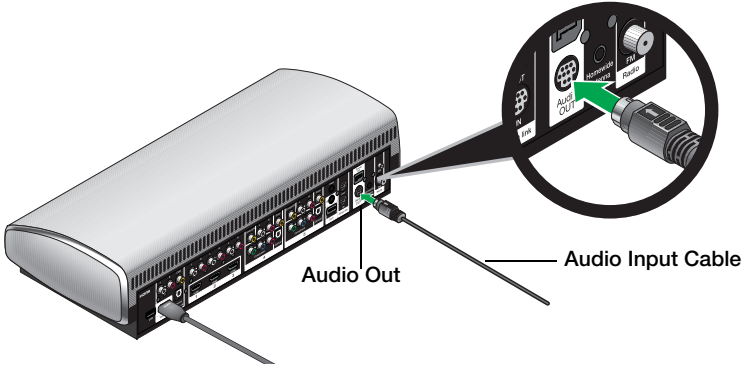

- E.** Plug the power supply output cord into the connector labeled **Power**.

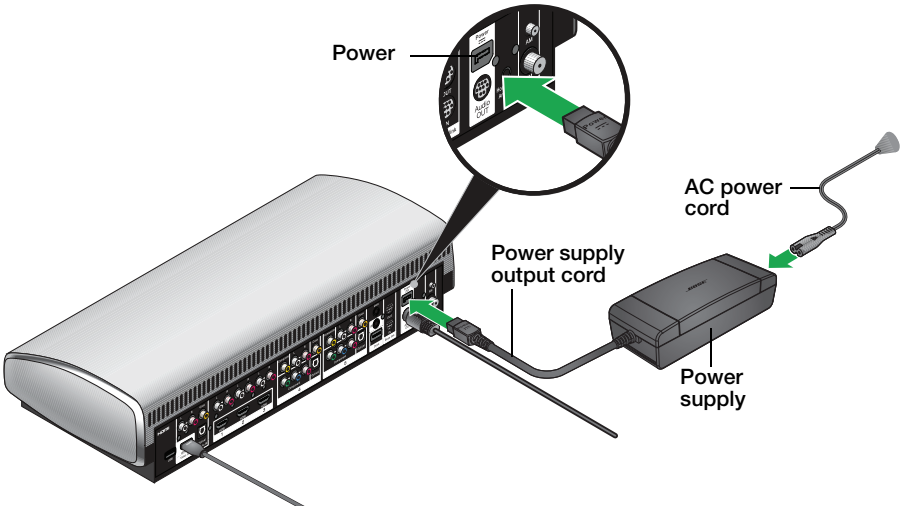

- F.** Plug a power cord into the power supply.

- G.** Plug the power cords from the speaker array and the control console into an AC (mains) power outlet.

Step 3: Set up the Acoustimass® module

What you need for the following steps:

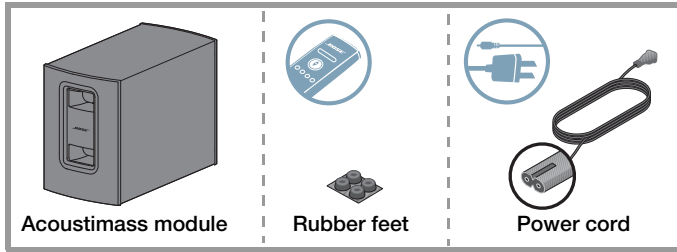

CAUTION: Choose a stable and level surface for the Acoustimass module. Vibration can cause the speaker to move, particularly on smooth surfaces like marble, glass, or highly polished wood.

- A.** When placing the Acoustimass® module on bare floors, or other smooth surfaces, attach the included rubber feet to the bottom of the module for greater stability and to protect your floor.

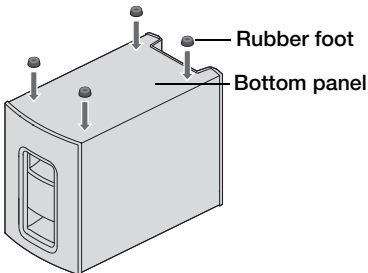

- B.** Plug the small end of the power cord into the **Power** connector.

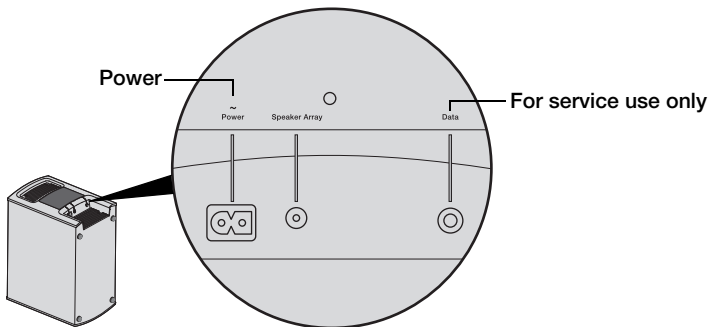

C. Place the Acoustimass® module according to the following guidelines:

- For best sound quality, stand the Acoustimass module on its feet along the same wall as your TV, or along any other wall in the front third of the room.
- The front opening of the module can face any direction.
- Make sure there is an AC outlet nearby.

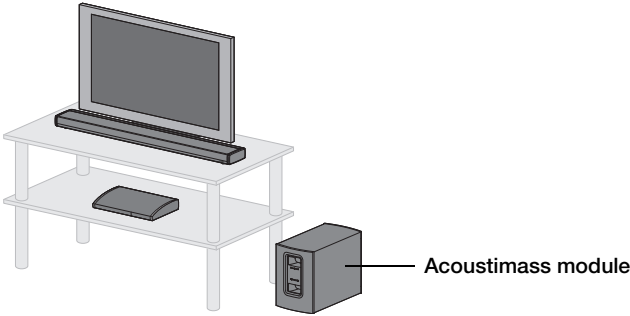

CAUTION: Do not operate the Acoustimass module on its front end, back end, side, or top.

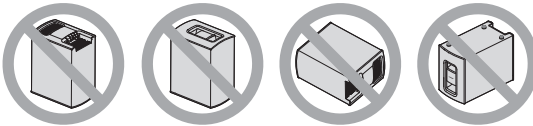

Note: Be sure to remove all protective films from the Acoustimass module before operating the system. They may affect acoustic performance if left in place.

D. Plug the Acoustimass module power cord into an AC (mains) power outlet.

First time startup

What you need for the following steps:

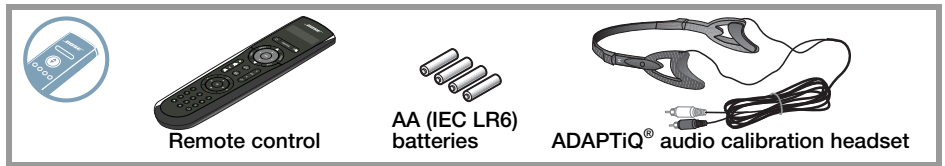

Before you start:

- Do not connect any devices to the control console at this time. The instructions provided on your TV will tell you when to do this.
- Make sure the speaker array and Acoustimass module are in their final positions before performing the ADAPTiQ audio calibration.

Step 1: Set up the remote control

- A. Slide the battery compartment cover off the back of the remote control.

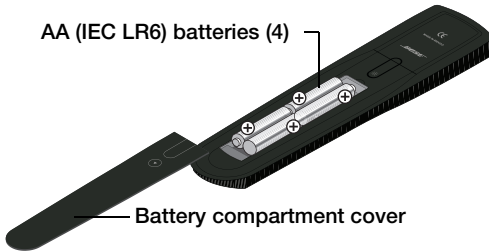

- B. Install four AA (IEC LR6) batteries, matching the polarity markings (+ and -) to the markings inside the battery compartment.
- C. Slide the battery cover back into place.

Step 2: Turn your system on and follow the on-screen instructions

- A. Press the power button (⏻) on the control console to turn on your system.

Because the system is in a low power state when in standby, it takes several seconds to start. When the power light on the control console changes from blinking to steady green, your system is ready to use.



- B. Check that the status indicator on the speaker array is off.

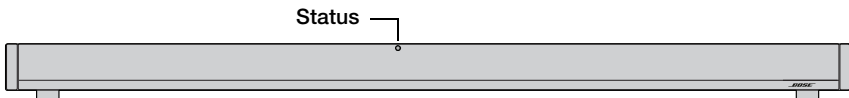

If the Status indicator is blinking orange:

- There is no wireless connection between the speaker array and the Acoustimass® module.
- See the Troubleshooting table in the back of the operating guide and follow the instructions for correcting the problem of “No Sound.”

- C.** Turn on your TV.
- D.** Using the remote that came with your TV, change the TV input to the one that is connected to your LIFESTYLE® system.
- E.** Follow the instructions on your TV screen. You will be prompted to do the following:
 - Select your language.
 - Run the ADAPTiQ® audio calibration system.
 - Connect and set up audio/video devices using the UNIFY® intelligent integration system.
 - Configure your Bose® remote to control your connected devices.

If you have setup problems

If you experience any difficulties during the setup process, such as an unrecognized device remote or a connection error, you can go to the UNIFY menu at any time and correct or change part of your system setup. See “Changing Your System Setup” in your system operating guide.

For help in trying to resolve any problems, see the troubleshooting table in your system operating guide.

Contacting customer service

For additional help in solving problems, contact Bose® Customer Service. See the address sheet included with your system.



342796-0010

BOSE[®]
Better sound through research[®]

2011 Bose Corporation, The Mountain,
Framingham, MA 01701-9168 USA
AM342796 Rev 00